

An abstract graphic design featuring several blue circles of varying sizes and shades, connected by thin blue lines. The circles are arranged in a way that suggests a flow or a sequence, with one small circle on the left and two larger circles on the right. The text is positioned on the left side of the image, overlaid on the graphic.

**ELEZ
FOREIGN
TRADE
MACHINE
CATALOG**

ELEZ FOREIGN TRADE



Since 1994, Istanbul / Turkey

**PLASTIC PIPE AND PLASTIC PIPE
MACHINE AND FOOD operating a
foreign trade company
specializing in industry. Services
and products are "healthy quality
standards, products / services" to
meet the highest level of the
principle acts.**

**Web:elezforeigntrade.weebly.com
Adress:İstanbul/TURKEY**

PRODUCTS & MANUFACTURER

- 1- PPR-C PIPE EXTRUDER MACHINE LINE**
- 2- ALUMINUM PIPE EXTRUDER MACHINE LINE**
- 3- Glass fiber pipe extruder machine line**
- 4- PVC-PP-PIPE EXTRUDER MACHINE LINE**
- 5- PE 100 PIPE EXTRUDER MACHINE LINE**
- 6- P80 GAS PIPE EXTRUDER MACHINE LINE**
- 7- DRIPPING PIPES MACHINE LINE**
 - a-COOLING BATHS MACHINE**
 - b-CATERPILLAR HAUL-OFF**
 - c-AUTOMATIC CUTTING UNIT&PIPE CUTTING**
 - d-TIP-OFF UNIT**
 - e-HEAD AND DIE SYSTEM**
 - f-VACUUM CALIBRATION SLEEVE**
- 8-PLASTIC INJECTION MACHINE**
- 9-PPR-C –PP-PVC FITTING MOULD**
- 10-BLOW MOLDING MACHINE**
- 11-PIPE WELDING MACHINE**



PPR-C PIPE EXTRUDER MACHINE LINE





ALUMINUM PIPE EXTRUDER MACHINE LINE

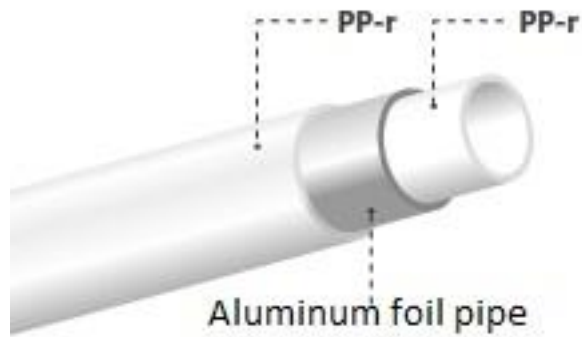



Glass fiber pipe extruder machine line

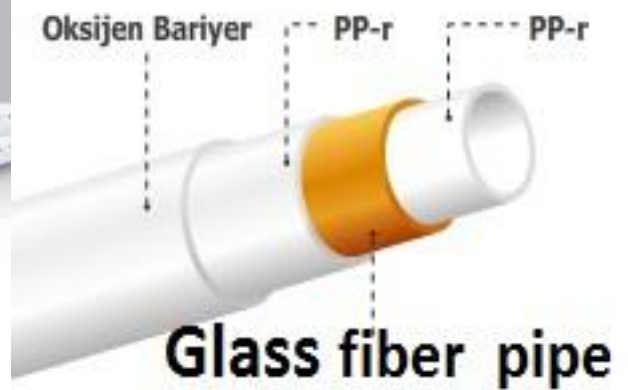



PVC-PP-PIPE EXTRUDER MACHINE LINE

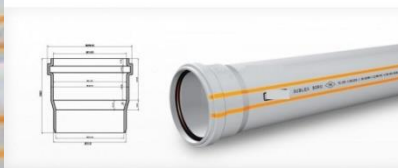

twin screw extruder



PE 100 PIPE EXTRUDER MACHINE LINE

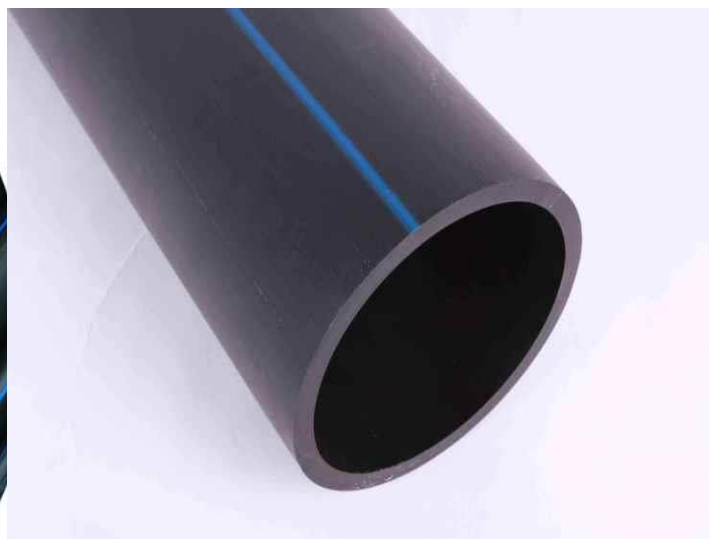

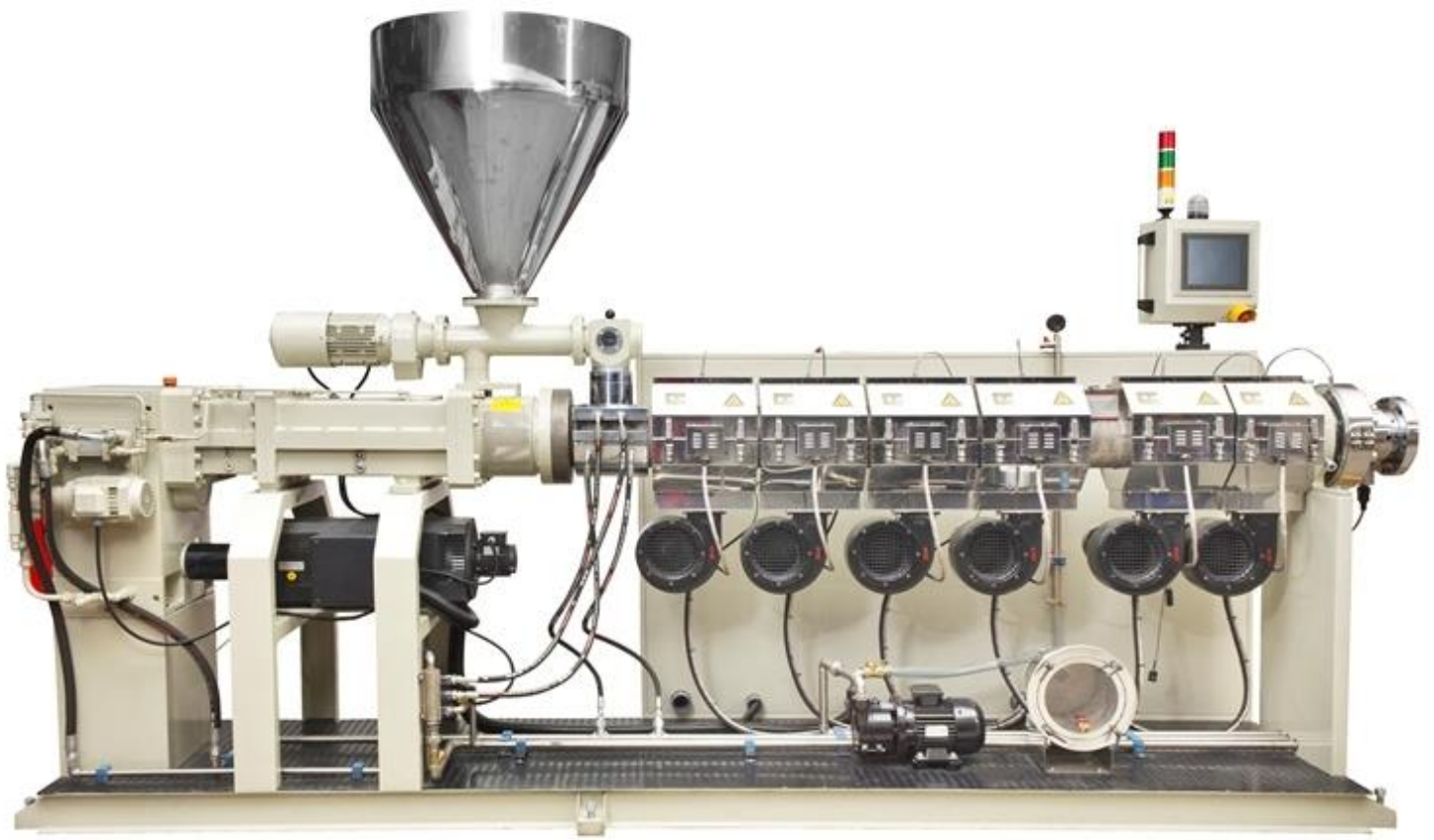

P80 GAS PIPE EXTRUDER MACHINE LINE



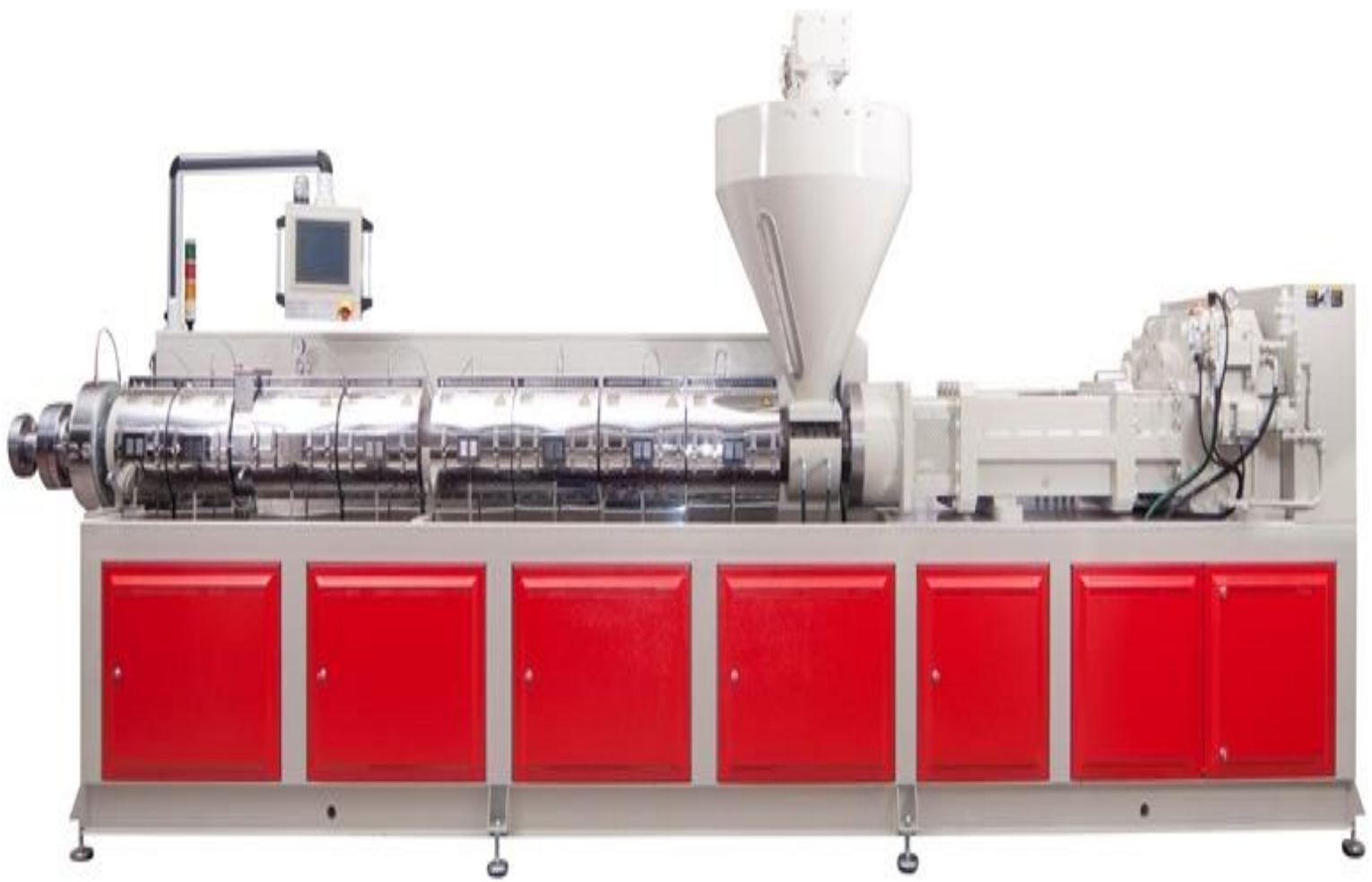

DRIPPING PIPES MACHINE LINE

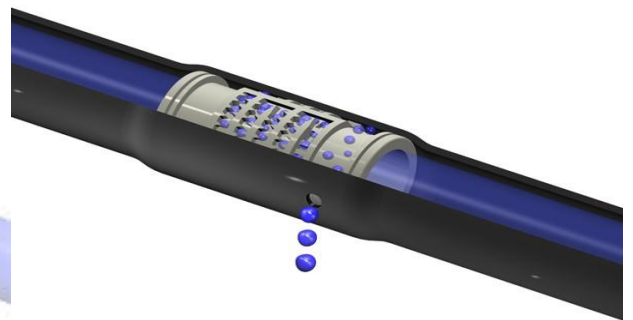



COOLING BATHS MACHINE



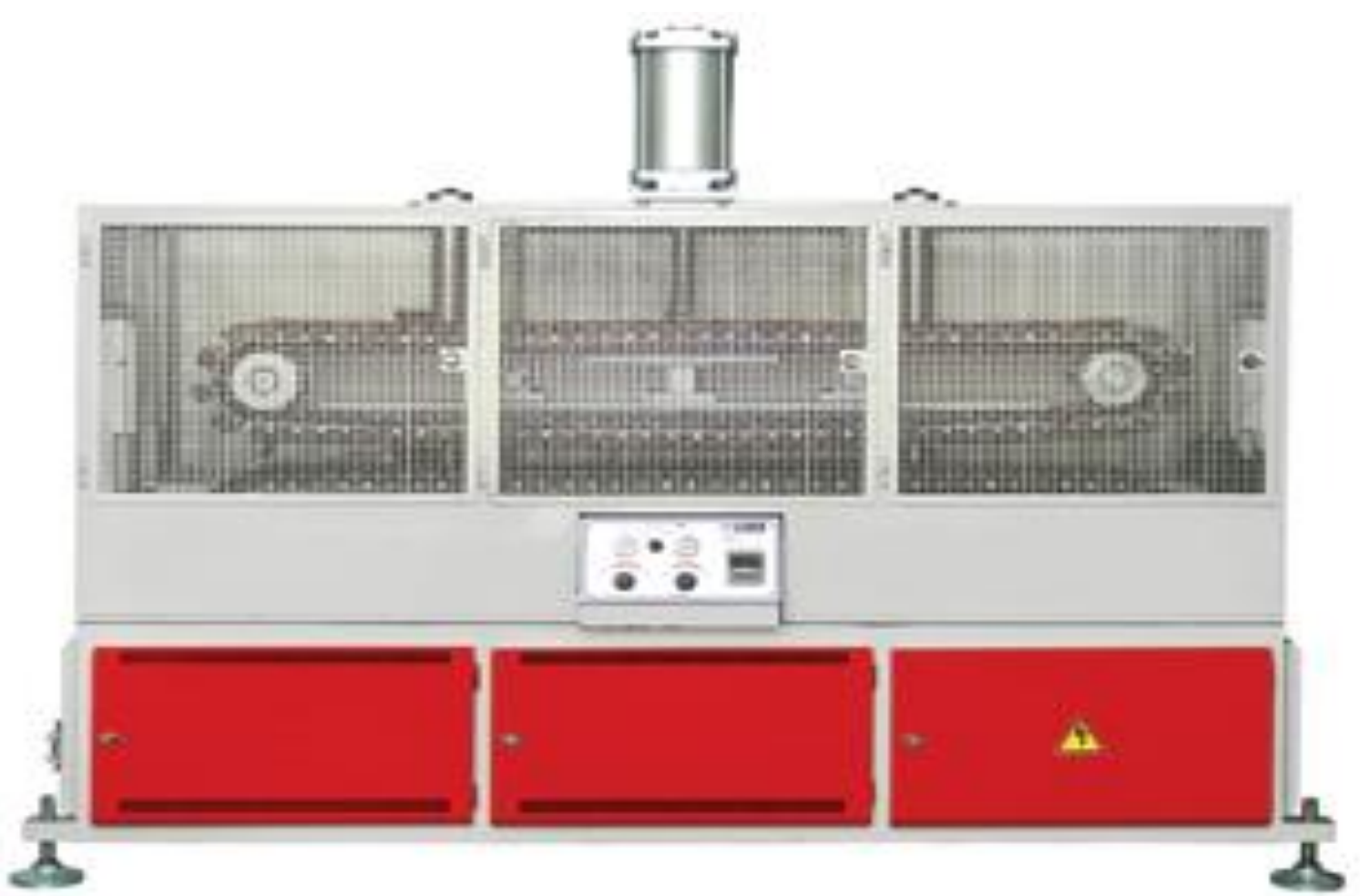

CATERPILLAR HAUL-OFF

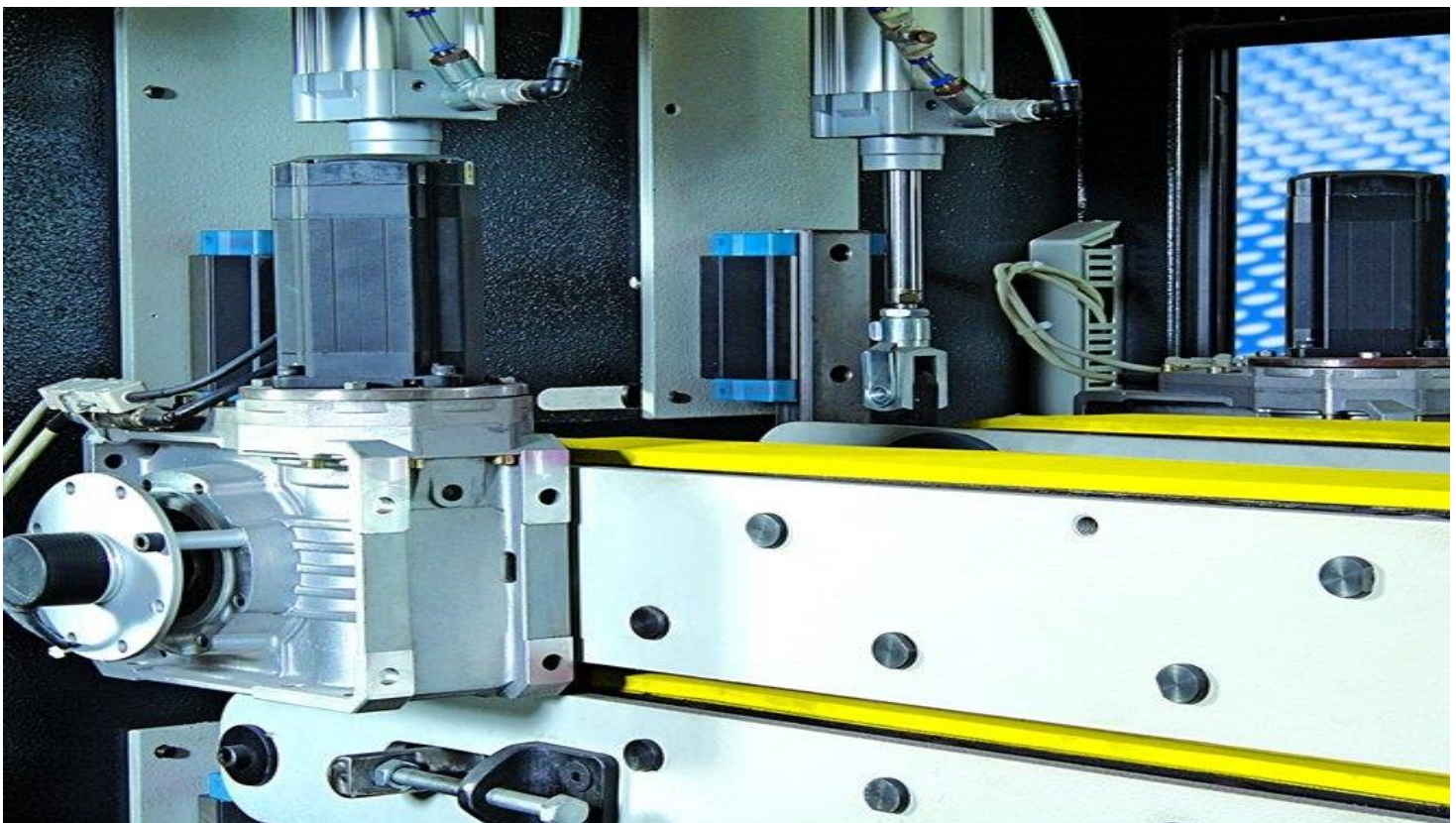

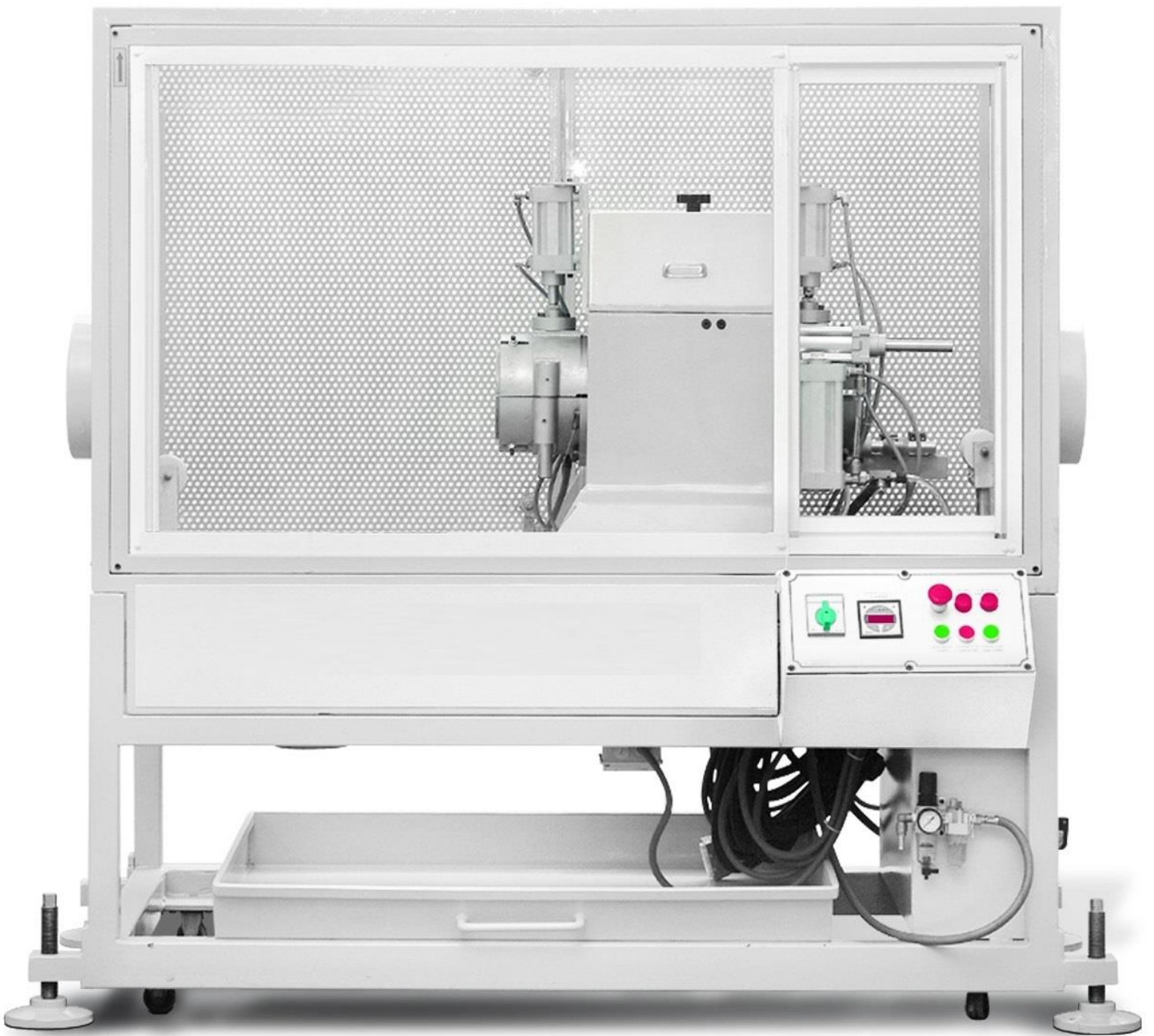

AUTOMATIC CUTTING UNIT&PIPE CUTTING



TIP-OFF UNIT

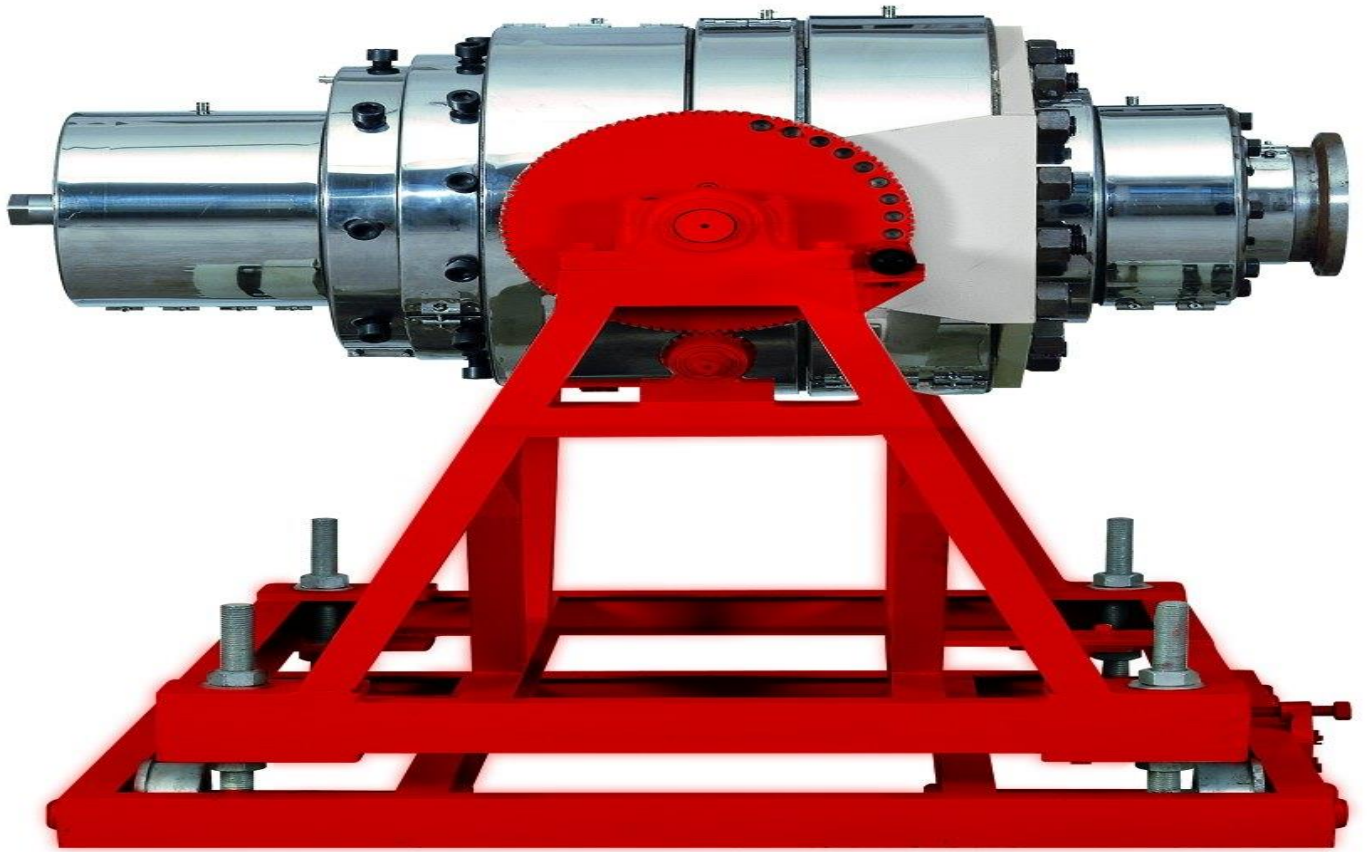
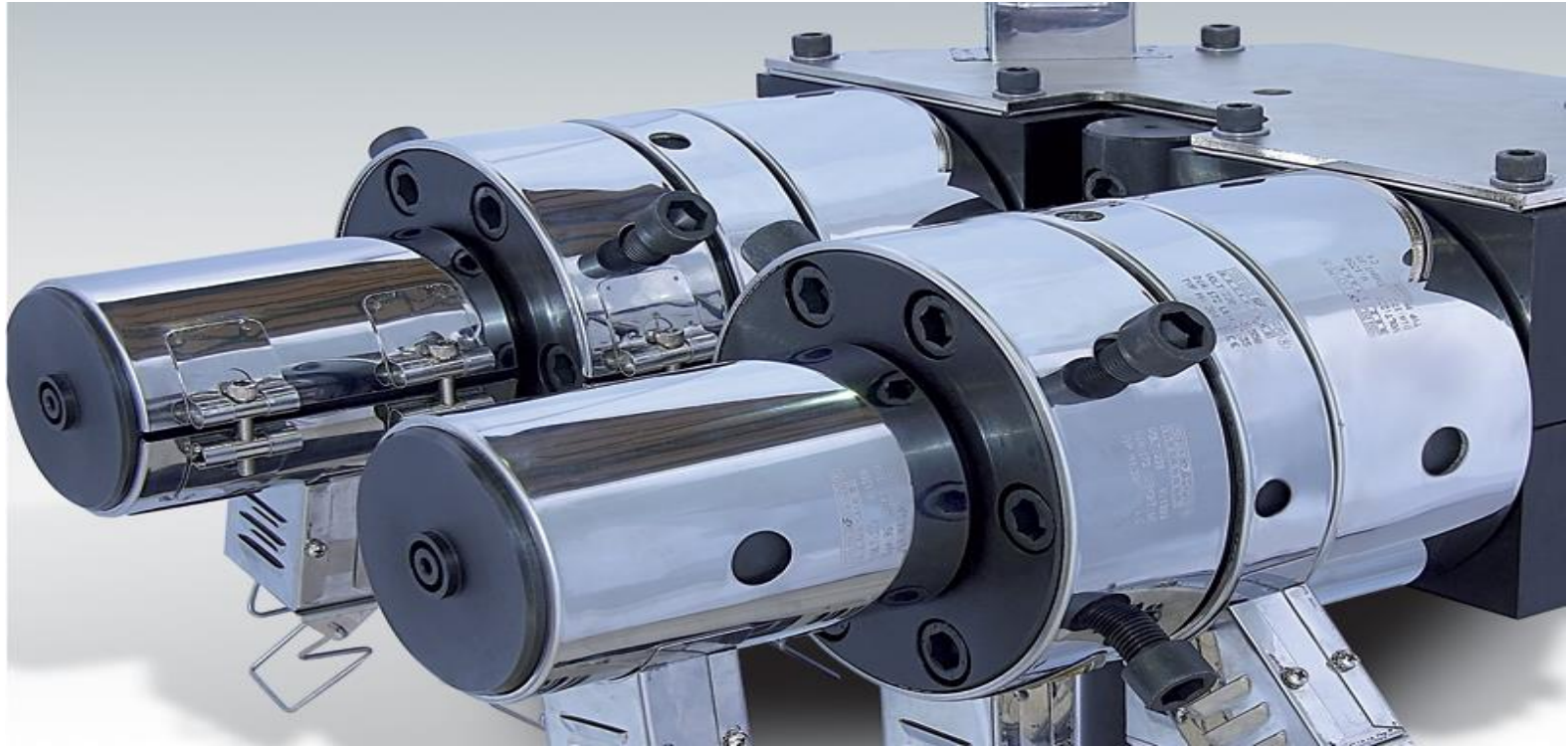

HEAD AND DIE SYSTEM



VACUUM CALIBRATION SLEEVE



PLACTIC INJESTION MACHINE



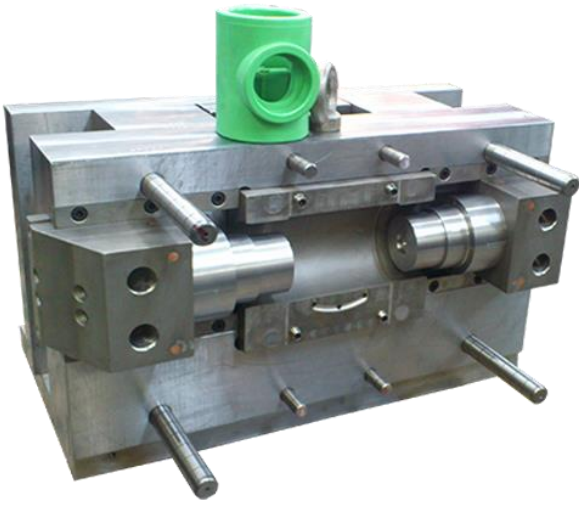

PPR-C –PP-PVC FITTING MOULD

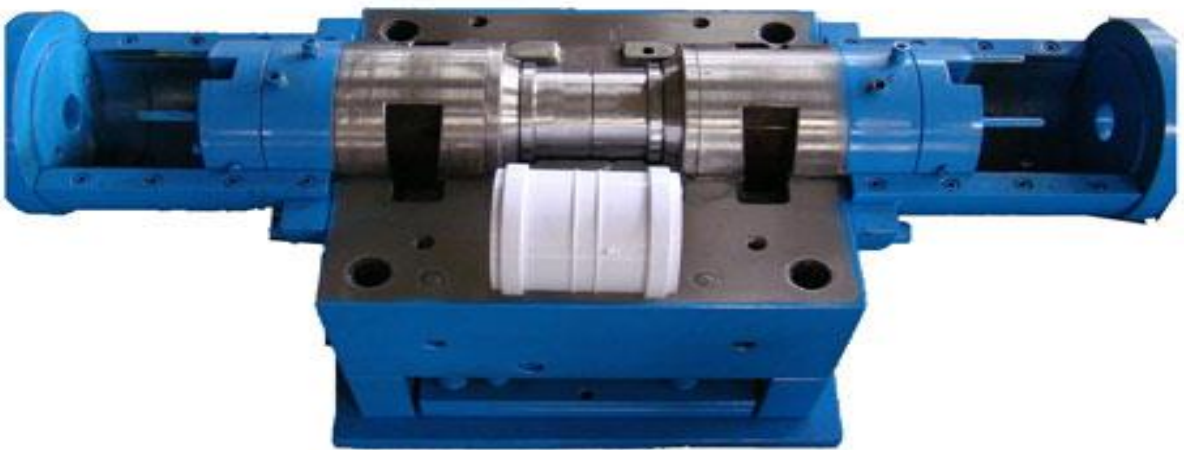

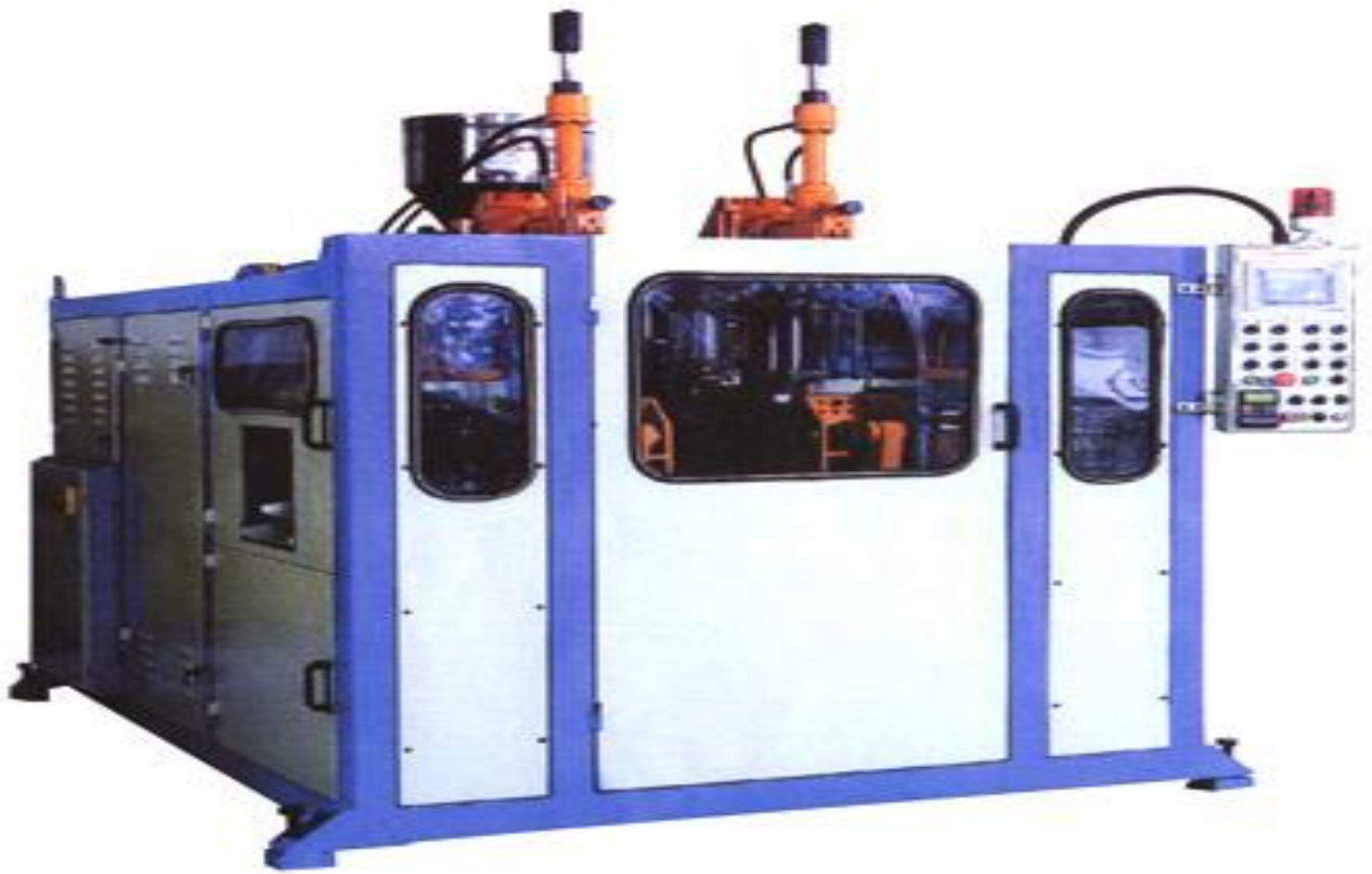

BLOW MOLDING MACHINE





PIPE WELDING MACHINE

